



offer 2026 **2027**

Legend



BASIC RANGE

kategoria narzędzi wytwarzanych z tworzywa w 100% pochodzącego z recyklingu
a category of tools made from 100% recycled material

PEAKSNOW



STANDARD RANGE – 3 YEARS WARRANTY

kategoria narzędzi i akcesoriów o bardzo dobrych parametrach użytkowych, wytrzymałościowych i ergonomicznych, wykonanych z wysokiej jakości surowca, 3 lata gwarancji
a category of tools and accessories with very good performance, durability and ergonomics, made of high-quality raw material, 3-year warranty

PEAKSNOW



PREMIUM – 5 YEARS WARRANTY

kategoria narzędzi profesjonalnych o zaawansowanej konstrukcji, dopracowanej pod kątem wytrzymałości, wydajności i ergonomii, wykonanych z najwyższej jakości surowca, 5 lat gwarancji
a category of professional tools with advanced design, refined for strength, performance and ergonomics, made of the highest quality raw material, 5-year warranty



symbol
symbol



kod EAN
EAN code



ilość sztuk na europalecie
number of pieces on an Europalette



zmontowane
assembled



nie zmontowane
not assembled



nie zmontowane
not assembled



ilość sztuk - TIR
truck quantity



Follow us
to find
more!



Visit our website
www.prosperplast.pl

Making the right and informed decisions – combined with production technologies and continuous innovation have led to Prosperplast's rapid growth.

We think forward and ahead of time, so we can develop the best products on the market. With the growth of technology and continual evolution of consumer demands, our online presence had a makeover, so we can serve our B2B clients and help our B2C customers in a better online environment. Developing our new website we had three core objectives: to interest, inspire and educate. We can proudly say we have achieved all three goals and will continue growing our online platform to support our current and new customers on daily basis.

Our product offering is growing, so is our virtual world! Sign up to the Newsletter on our website to stay up to date with news from the world of Prosperplast.



Index regular offer





p. 14

SNOWER 55 ALUTUBE



p. 15

SNOWER 55 PROFI



p. 15

SNOWER 55 PROFI ERGO



p. 16

SNOWER 55D ALUTUBE



p. 17

SNOWER 55D PROFI



p. 17

SNOWER 55D PROFI ERGO



p. 24

ALUMAX



p. 24

ALUMAX S



p. 25

ALUMAX ERGO



p. 30

ERGOMETAL



p. 31

ALPE 50 TELESCOPIC



p. 31

STANDARD 1



p. 32

STANDARD 2



p. 32

NANGA CAR TELESCOPIC



p. 33

EVEREST



p. 33

LHOTSE



p. 38

ALUICE 50



p. 39

ALUICE 50 P



p. 39

SKANDYNAWIA 2



p. 40

ICE 1



p. 40

ICE 2



p. 41

ICE 3



p. 41

SHARKIE



p. 46

BOBO



p. 46

IGLOO COMFORT



p. 47

IGLOO COMFORT ALU



p. 47

KIDY



p. 48

LOAD BABY



p. 48

LOAD BABY ALU



p. 49

FOCUS BABY



p. 54

NANGA ECO CAR TELESCOPIC



p. 55

EVEREST ECO



p. 56

ARCTIC ECO



p. 56

ARCTIC L ECO

ask for MOQ special order



BASIC RANGE



PEAKSNOW



STANDARD

3 YEARS WARRANTY



PEAKSNOW



PREMIUM

5 YEARS WARRANTY





p. 62

ALPE 40 ECO TELESCOPIC



p. 62

NANGA ECO CAR



p. 63

NANGA ECO



p. 63

NANGA ECO CAR ALU



p. 64

NANGA ECO TELESCOPIC



p. 68

ALPINUS ERGOMETAL



p. 68

ALPINUS TELESCOPIC



p. 69

ERGONOMIC 1 A



p. 69

ERGONOMIC 2 A



p. 70

ERGO ALUTUBE



p. 70

ALPE 40 TELESCOPIC



p. 71

NANGA



p. 74

ICE SET



p. 75

FAMILY SET



p. 75

KID SET



p. 76

BOBO COMFORT



p. 76

BOBO COMFORT ALU











p. 77

IGLOO

SNOW MOVER

snow blower

		I LSM600
	S411	5905197369334
	not assembled	 +  30
	not assembled	 +  990



-32°

5 YEARS WARRANTY

SYSTEM UNI-PACK

powder-coated metal handle Ø 20 mm

auger

steel edge





easiest way
to remove snow



click
system

Najbardziej ekologiczna opcja dostępna na rynku!
Ręczny pług do śniegu wyposażony w ślimakowy przenośnik wyrzucający śnieg na prawą stronę, co znacznie przyspiesza proces odśnieżania dużych powierzchni, również na terenie obiektów przemysłowych. Krawędź natarcia zabezpieczona aluminiowym okuciem. System połączenia sztyla z łyżką zgarniacza ułatwia montaż dla celów użytkowania i przechowywania. Mrozoodporny.

*The most eco-friendly option available on the market!
A hand powered manual snow blower shovel equipped with an auger that throws snow aside, which significantly speeds up snow removal from driveway and large areas, including industrial facilities.
The blade is reinforced with aluminum edge.
Click on/off connection system is a perfect solution for comfortable use and storage. Frostresistant.*

PEAKSNOW



series

PREMIUM

PROFESSIONAL SHOVELS



STRONG



DURABLE



FLEXIBLE



THERMO-STOP



4 SEASONS



PUSH & UNLOAD

c
o
m
p
o
n
e
n
t
s

two-position locking connector
which ensuring easy assembly
for use and disassembly for storage

reinforced construction

shaft tip

wide working
edge protected
with aluminum
edge

deep blade



Cenione przez użytkowników technicznie zaawansowane, profesjonalne i bardzo wytrzymałe narzędzia na długie lata. Wypróbowane w trudnych warunkach, trwałe i odporne.

Wysokie parametry użytkowe i ergonomiczne, konstrukcja dopracowana pod kątem wytrzymałości, wydajności i uniwersalności zastosowań. Zastosowane innowacyjne rozwiązania zapewniają bardzo wysoką ergonomię i komfort pracy.

Valued by users these technically advanced, professional and very durable tools will last you for many years to come. The range has been tried in extreme conditions and proved to be durable and resistant for weather conditions.

Their high performance and ergonomic design, manufacture with consistency and attention to details make them required by the professionals and every day users. The innovative solutions used in design and manufacturing will ensure very high ergonomic and comfort at work.





SNOWER

40



Wytrzymała wielozadaniowa łopata do całorocznych zastosowań, o świetnych parametrach technicznych, wyposażona w wygodną dwukomponentową rączkę. Krawędź natarcia zabezpieczona aluminium okuciem. Mrozoodporna. Zastosowano innowacyjny system połączenia sztyła z korpusem łopaty za pomocą obrotowego 2-biegunowego (dwupozycyjnego) łącznika blokującego, zapewniający łatwy montaż dla celów użytkowania i demontaż na czas przechowywania.

Durable multi-purpose shovel for all season purposes with excellent technical parameters, equipped with a 2-component convenient handle.

The working edge is reinforced with an aluminum ferrule. Frost resistant.

An innovative system of connecting the shovel with the blade using a rotating, 2 (two-position) locking connector which ensuring easy assembly for use and disassembly for storage.



SNOWER 40 ALUTUBE

professional snow shovel

	IAR40TB
	R444 5905197222257
	not assembled 300 200
	assembled 60
	not assembled 3900 3900
	assembled 1920



ergonomic two-component D-grip IU-14

aluminium handle Ø 30 mm
rubber athermal cover

uni-pack system

aluminium edge



T O T A L 1340 mm

354 mm

397 mm

140 mm

PEAKSNOW



SNOWER 40 PROFI

professional snow shovel

	IAR40LXP
	R444 5905197222288
	not assembled 300 200
	assembled 60
	not assembled 3900 3900
	assembled 1920



ergonomic two-component D-grip IU-14

profiled aluminium handle
rubber athermal cover

uni-pack system

aluminium edge



PEAKSNOW



SNOWER 40 PROFI ERGO

professional snow shovel

	IAR40EP
	R444 5905197222271
	not assembled 300 200
	assembled 60
	not assembled 3900 3900
	assembled 1920



ergonomic two-component D-grip IU-14

ergonomic profiled aluminium handle
rubber athermal cover

uni-pack system

aluminium edge



PEAKSNOW



SNOWER 50



Profesjonalna, wytrzymała łopata do odśnieżania, o świetnych parametrach technicznych i szerokiej krawędzi natarcia, zabezpieczonej aluminiowym okuciem. Wyposażona w wygodną dwukomponentową rączkę. Mrozoodporna. Zastosowano innowacyjny system połączenia sztylu z korpusem łopaty za pomocą obrotowego 2-biegunowego (dwupozycyjnego) łącznika blokującego, zapewniający łatwy montaż dla celów użytkowania i demontaż na czas przechowywania.

A professional, durable snow shovel with excellent technical parameters and a wide working edge protected with an aluminum ferrule. Equipped with a comfortable 2-component handle. Frost resistant. An innovative system of connecting the shovel with the blade using a rotating, 2 (two-position) locking connector which ensuring easy assembly for use and disassembly for storage.

PEAKSNOW



SNOWER 50 ALUTUBE professional snow shovel

	IAR50TB
	R444 5905197222301
	not assembled 240 200
	assembled 50
	not assembled 3600 3600
	assembled 1600



ergonomic two-component D-grip IU-14

aluminium handle Ø 30 mm
rubber athermal cover

uni-pack system

aluminium edge

permanent fix once click





SNOWER 50 PROFI

professional snow shovel

	IAR50LXP
	R444 5905197222332
	not assembled 240 200
	assembled 50
	not assembled 3600 3600
	assembled 1600



ergonomic two-component
D-grip IU-14



SNOWER 50 PROFI ERGO

professional snow shovel

	IAR50EP
	R444 5905197222325
	not assembled 240 200
	assembled 50
	not assembled 3600 3600
	assembled 1600



ergonomic two-component
D-grip IU-14



PEAKSNOW



SNOWER 55



Niezawodna, wydajna łopata do odśnieżania, o wzmocnionej konstrukcji, wytrzymałej silny nacisk i szerokiej krawędzi natarcia, zabezpieczonej aluminium okuciem. Wyposażona w wygodną dwukomponentową rączkę. Mrozoodporna. Zastosowano innowacyjny system połączenia sztylu z korpusem łopaty za pomocą obrotowego 2-biegunowego (dwupozycyjnego) łącznika blokującego, zapewniający łatwy montaż dla celów użytkowania i demontaż na czas przechowywania.

Reliable, efficient snow shovel with reinforced structure that withstands strong pressure and a wide working edge protected with aluminum ferrule. Equipped with a comfortable 2-component handle. Frost resistant. An innovative system of connecting the shovel with the blade using a rotating, 2 (two-position) locking connector which ensuring easy assembly for use and disassembly for storage.

PEAKSNOW



SNOWER 55 ALUTUBE professional snow shovel

	IAR55TB
	R444 5905197222356
	not assembled 240 200
	assembled 50
	not assembled 3600 3600
	assembled 1600



ergonomic two-component
D-grip IU-14

aluminium handle Ø 30 mm
rubber athermal cover

uni-pack system

aluminium
edge

permanent fix
once click

T O T A L 1360 mm

385 mm

545 mm

89 mm

PEAKSNOW



SNOWER 55 PROFI

professional snow shovel

	IAR55LXP
	R444 5905197222387
	not assembled 240 200
	assembled 50
	not assembled 3600 3600
	assembled 1600



ergonomic two-component D-grip IU-14



PEAKSNOW



SNOWER 55 PROFI ERGO

professional snow shovel

	IAR55EP
	R444 5905197222370
	not assembled 240 200
	assembled 50
	not assembled 3600 3600
	assembled 1600



ergonomic two-component D-grip IU-14



PEAKSNOW



SNOWER 55D



Bezkonkurencyjne, bardzo pojemne narzędzie do zadań specjalnych, o wzmocnionej konstrukcji, wytrzymującej silny nacisk i szerokiej krawędzi natarcia, zabezpieczonej aluminiowym okuciem. Wyposażona w wygodną dwukomponentową rączkę. Mrozoodporna. Zastosowano innowacyjny system połączenia sztyla z korpusem łopaty za pomocą obrotowego 2-biegunowego (dwupozycyjnego) łącznika blokującego, zapewniający łatwy montaż dla celów użytkowania i demontaż na czas przechowywania.

An unique, very capacious tool for special tasks with a reinforced structure that withstands strong pressure and a wide leading edge protected with an aluminum ferrule. Equipped with a comfortable 2-component handle. Frost resistant. An innovative system of connecting the shovel with the blade using a rotating, 2 (two-position) locking connector which ensuring easy assembly for use and disassembly for storage.

PEAKSNOW



SNOWER 55D ALUTUBE professional snow shovel

	IARG55TB
	R444 5905197222400
	not assembled 160 200
	assembled 50
	not assembled 2880 2880
	assembled 1600



ergonomic two-component
D-grip IU-14

aluminium handle Ø 30 mm
rubber athermal cover

uni-pack system

aluminium
edge



PEAKSNOW



SNOWER 55D PROFI

professional snow shovel

	IARG55LXP
	R444 5905197222431
	not assembled 160 200
	assembled 50
	not assembled 2880 2880
	assembled 1600



ergonomic two-component D-grip IU-14



PEAKSNOW



SNOWER 55D PROFI ERGO

professional snow shovel

	IARG55EP
	R444 5905197222424
	not assembled 160 200
	assembled 50
	not assembled 2880 2880
	assembled 1600



ergonomic two-component D-grip IU-14





Unikalna i progresywna myśl konstrukcyjna! To inteligentne rozwiązanie typu 2 w 1 zastosowane zostało dla podniesienie komfortu oraz efektywności grabienia i zagarniania sporych partii liści, trawy czy materiałów sypkich. Łopatograbie wyposażone są w duże, szeroko rozstawione zęby oraz aluminiowy sztyl i wygodną dwukomponentową rączkę. Mrozooodporne. Zastosowano innowacyjny system połączenia sztyli z korpusem za pomocą obrotowego 2-biegunowego (dwupozycyjnego) łącznika blokującego, zapewniający łatwy montaż dla celów użytkowania i demontaż na czas przechowywania.

Unique and progressive design idea! This smart 2in1 solution is designed to enhance comfort and efficiency when raking and scooping up large amounts of leaves, grass or loose materials. The rake loader features large, wide-spaced teeth, an aluminium haft and a comfortable two-component handle. Frost-proof. The innovative haft-to-body connection system with a 2-pole (two-position) rotating locking connector to enable easy installation for use and removal for storage was used.



RAKE LOADER

spade-rake / special task-tool 2in1

	ILG2
S411	5905197267654
not assembled	300 200
assembled	60
not assembled	3900 3900
assembled	1920



ergonomic two-component D-grip IU-14

profiled aluminium handle
rubber athermal cover

uni-pack system

easy to assemble & disassemble thanks to the „twist” connector





DIABLO

professional shovel

	ILDB
	R444 5905197141596
	not assembled 160 300
	assembled 70
	not assembled 3360 3360
	assembled 2240



ERGOSPECIAL







professional shovel

	ILEX55
	B333 5905197141695
	not assembled 160 320
	assembled 70
	not assembled 3520 3520
	assembled 2240



SNOW MONSTER

professional pusher

	ILMON
 S411	5905197142302
 assembled	 20
 assembled	 660



powder-coated metal handle Ø 20 mm

uni-pack system

aluminium or steel edge



easy to assemble & disassemble

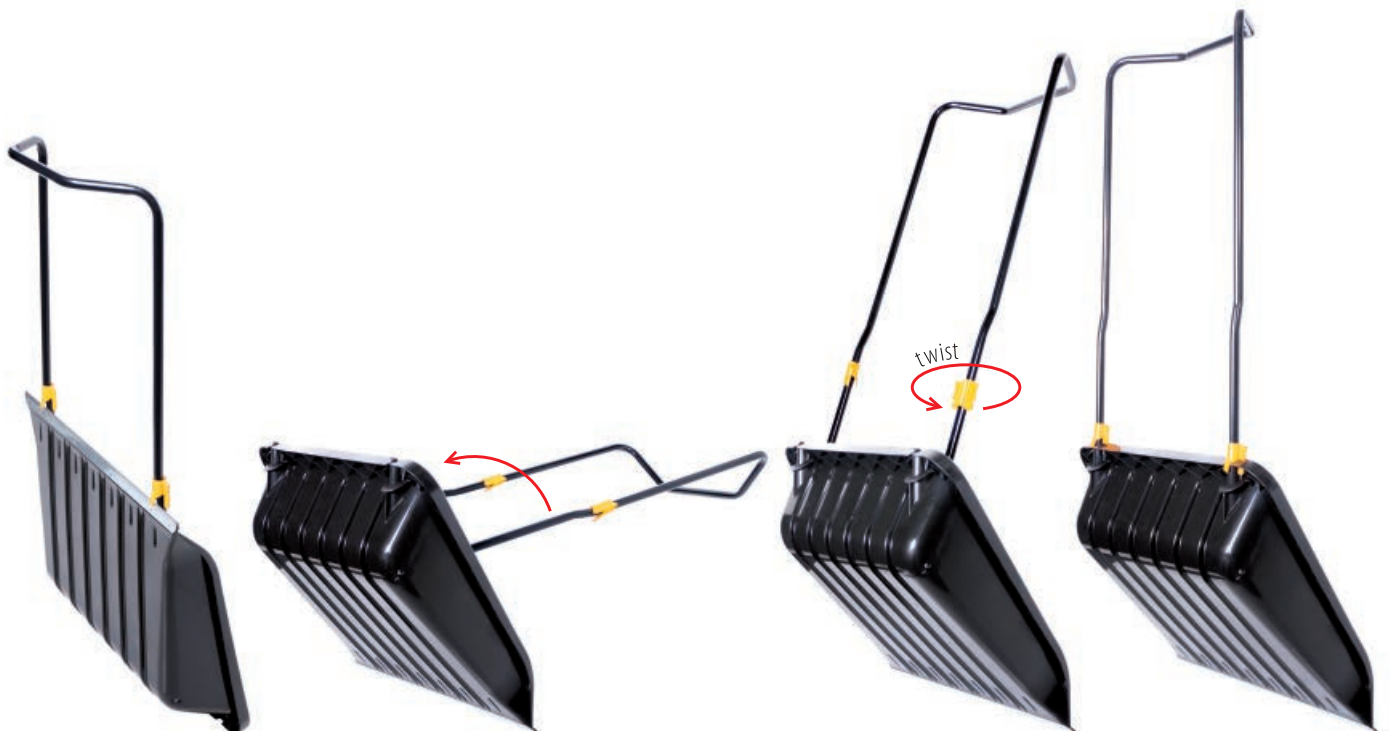

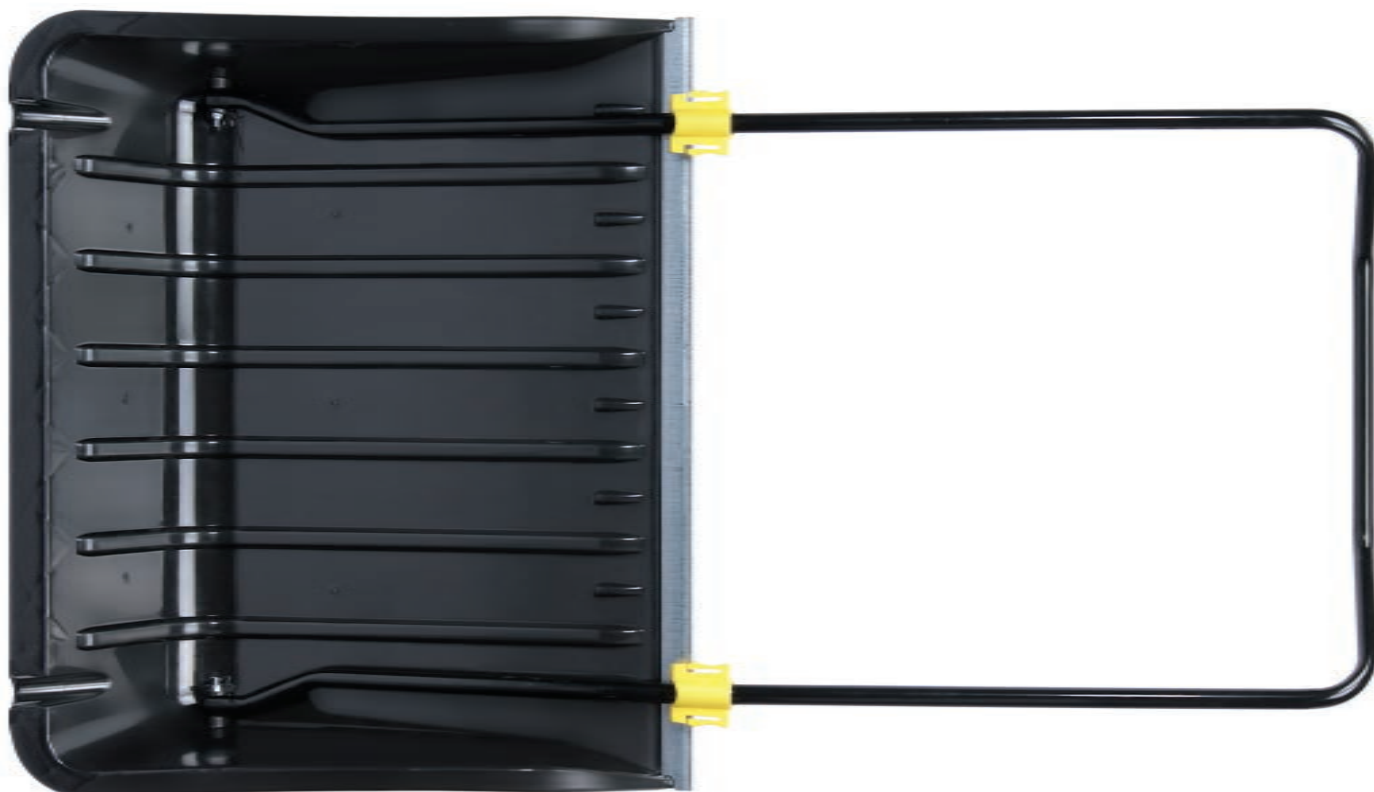

lock system

Bardzo wytrzymały wydajny zgarniacz do większych zastosowań, sprawdzający się przy odśnieżaniu dużych powierzchni, również na terenie obiektów przemysłowych. Zastosowano innowacyjne połączenie sztyła z łyżką zgarniacza, ułatwiające montaż dla celów użytkowania i przechowywania. Krawędź natarcia zabezpieczona aluminiowym okuciem. Mrozoodporny.

A heavy duty, effective pusher for snow removal from larger areas including industrial facilities. An innovative connection of a shaft and blade make it a perfect solution for usage comfort and storage. The blade is reinforced with aluminum edge. Frost resistant.

PEAKSNOW



MAKALU

car shovel

	ILSN1
CPNO	5905197140438
assembled	120
assembled	7920



polycarbonate D-grip IU-4

anodized aluminium
handle Ø 30 mm
click-system

polycarbonate





ALUEDGE

aluminium shovel

	I LEGM
ALU	5905197142241
assembled	80
assembled	2640



ALUEDGE ERGO

aluminium shovel

	I LEGDE
ALU	5905197142258
assembled	80
assembled	2640





ALUMAX

aluminium shovel

	ILMAXA
	5905197141541
	assembled
	80
	assembled
	2640



ALUMAX S

aluminium shovel

	ILMAXS
	5905197141558
	assembled
	80
	assembled
	2640



PEAKSNOW



ALUMAX ERGO

aluminium shovel



ILMAXAE



ALU

5905197142135



assembled



80



assembled



2640



D-grip IU-9

aluminium ergonomic
oval handle

rubber athermal cover

aluminium
edge



500 mm

65 mm

T O T A L 1505 mm

375 mm



PEAKSNOW



★★★★☆
S T A N D A R D

series

STANDARD RANGE

SHOVELS & ACCESSORIES

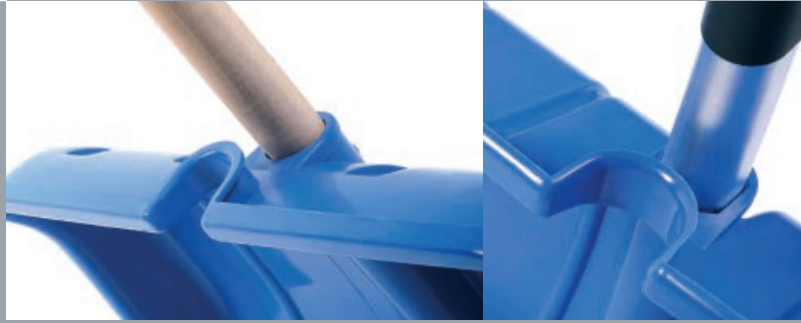

STRONG



DURABLE



FLEXIBLE



THERMO-STOP



4 SEASONS



PUSH & UNLOAD

S
t
e
n
e
n
o
p
c
o
m
p
o
n
e
n
t
s

rubber athermal cover

aluminium handle

D-grip

click-system

aluminium edge

Niezawodne, mrozooodporne, wielozadaniowe narzędzia, wypróbowane w każdych warunkach. Wysokie parametry użytkowe i ergonomiczne, konstrukcja dopracowana pod kątem wytrzymałości, wydajności i uniwersalności zastosowań.

Frost-resistant, multi-purpose tools ensure their durability and reliability in all condition. Their high performance and ergonomic design, manufacture with consistency and attention to details make them required by the professionals and every day users.

click
system



PEAKSNOW



ALPIN 1 A

snow shovel

	IL1A
	B333 5905197140537
	not assembled 360 1440
	assembled 160
	not assembled 8640 8640
	assembled 5280



D-grip IU-8

wooden shaft Ø 31 mm

uni-pack system

aluminium edge



PEAKSNOW



ALPIN 2 A

snow shovel

	IL2A
	B333 5905197140544
	not assembled 300 1440
	assembled 100
	not assembled 7500 7500
	assembled 3300



D-grip IU-8

wooden shaft Ø 31 mm

uni-pack system

aluminium edge



PEAKSNOW



ALPIN 2 METAL

snow shovel

	IL2AMT
	B333 5905197141213
	not assembled 300 350
	assembled 75
	not assembled 5400 5400
	assembled 2475



D-grip IU-4

powder-coated metal handle Ø 30 mm
rubber athermal cover

uni-pack system

aluminium edge

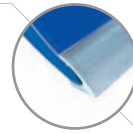

490 mm

95 mm

T O T A L 1470 mm

375 mm

PEAKSNOW



ALPIN 2 ALUTUBE

snow shovel

	IL2TB
	B333 5905197141237
	not assembled 300 350
	assembled 100
	not assembled 5400 5400
	assembled 3300



D-grip IU-4

aluminium handle Ø 30 mm
rubber athermal cover

uni-pack system

aluminium edge

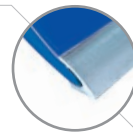

490 mm

95 mm

T O T A L 1430 mm

375 mm

PEAKSNOW



ALPINUS METAL

snow shovel

	IL3MTA
	B333 5905197141268
	not assembled 160 350
	assembled 70
	not assembled 3680 3680
	assembled 2240



D-grip IU-4

powder-coated metal handle Ø 30 mm
rubber athermal cover

uni-pack system

aluminium edge



PEAKSNOW



ALPINUS ALUTUBE

snow shovel

	IL3TB
	B333 5905197141275
	not assembled 160 350
	assembled 70
	not assembled 3680 3680
	assembled 2240



D-grip IU-4

aluminium handle Ø 30 mm
rubber athermal cover

uni-pack system

aluminium edge



PEAKSNOW



ALPINUS ALUTUBE ERGO

snow shovel

	IL3TBE
	B333 5905197441382
	not assembled 160 350
	assembled 70
	not assembled 3680 3680
	assembled 2240



D-grip IU-4

aluminium ergonomic handle Ø 30 mm
rubber athermal cover

uni-pack system

aluminium edge



PEAKSNOW



ERGOMETAL

snow shovel

	ILEFE
	B333 5905197141640
	not assembled 200 350
	assembled 100
	not assembled 4200 4200
	assembled 3300



D-grip IU-4

powder-coated metal ergonomic handle Ø 30 mm
rubber athermal cover

uni-pack system

aluminium edge



PEAKSNOW



ALPE 50 TELESCOPIC

snow shovel

	IL50TSC
	B333 5905197142074
	not assembled 300 250
	assembled 100
	not assembled 5400 5400
	assembled 3300



D-grip IU-11

telescopic system

aluminium handle Ø 26/30 mm
athermal cover

uni-pack system

aluminium edge



PEAKSNOW



STANDARD 1

snow shovel

	ILN1
	B333 5905197141725
	not assembled 240 1060
	assembled 90
	not assembled 5760 5760
	assembled 2970



D-grip IU-4

wooden shaft Ø 36 mm



PEAKSNOW



STANDARD 2

snow shovel

	ILN2
	B333 5905197141732
	not assembled 160 1000
	assembled 90
	not assembled 4160 4160
	assembled 2970



PEAKSNOW



NANGA CAR TELESCOPIC

car shovel

	ILNGTSC
	B333 5905197141435
	assembled 120
	assembled 7920



PEAKSNOW



EVEREST

car shovel

	ILS1
	B333 5905197140551
	assembled 140
	assembled 9240



PEAKSNOW



LHOTSE

car shovel

	ILHOT
	B333 5905197141633
	assembled 120
	assembled 7920



PEAKSNOW



★★★★☆
STANDARD

SNOW RIDER 1

pusher

	ILSR1
B333	5905197097329
R411	5905197094397
	not assembled + 50
	assembled 30
	not assembled + 3300
	assembled 990



powder-coated metal handle Ø 20 mm

uni-pack system

aluminium edge

wheels

800 mm

95 mm

T O T A L 1300 mm

425 mm

PEAKSNOW



★★★★☆
STANDARD

ARCTIC

pusher

	ILB
B333	5905197140575
	not assembled + 50
	assembled 30
	not assembled + 3300
	assembled 990

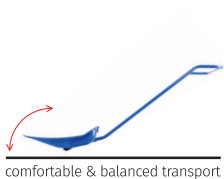

powder-coated metal handle Ø 20 mm

uni-pack system

aluminium edge

wheels

800 mm

115 mm

T O T A L 1270 mm

440 mm

PEAKSNOW



ARCTIC L pusher

	ILL
	B333 5905197141701
not assembled	100 100
assembled	18
not assembled	1600 1600
assembled	594

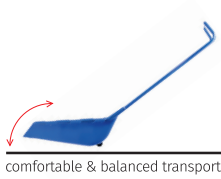

powder-coated metal handle Ø 22 mm

uni-pack system

aluminium edge

wheels



PEAKSNOW



ARCTIC XL pusher

	ILXL
	B333 5905197141718
not assembled	80 80
assembled	15
not assembled	1280 1280
assembled	495

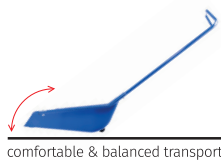

powder-coated metal handle Ø 22 mm

uni-pack system

aluminium edge

wheels



PEAKSNOW



★★★★☆
STANDARD

STRONGMAN 60

pusher

	ILZM60
STEEL	5905197141398
assembled	20
assembled	660

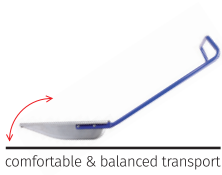

comfortable & balanced transport



powder-coated metal handle Ø 25 mm



PEAKSNOW



★★★★☆
STANDARD

STRONGMAN 80

pusher

	ILZM80
STEEL	5905197141404
assembled	12
assembled	396

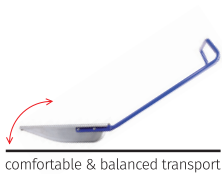

comfortable & balanced transport



powder-coated metal handle Ø 25 mm





PEAKSNOW



★★★★☆
STANDARD

ALUICE 40

aluminium shovel

	ILAL40
	ALU 5905197141749
	not assembled 600 1500
	assembled 60
	not assembled 12000 12000
	assembled 1980



PEAKSNOW



★★★★☆
STANDARD

ALUICE 50

aluminium shovel

	ILAL50
	ALU 5905197141756
	not assembled 600 1500
	assembled 60
	not assembled 12000 12000
	assembled 1980



PEAKSNOW



ALUICE 50 P

aluminium shovel

	ILALP5
	ALU 5905197141619
	not assembled 400 1000
	assembled 60
	not assembled 8000 8000
	assembled 1980



D-grip IU-4

wooden shaft Ø 30 mm

aluminium edge

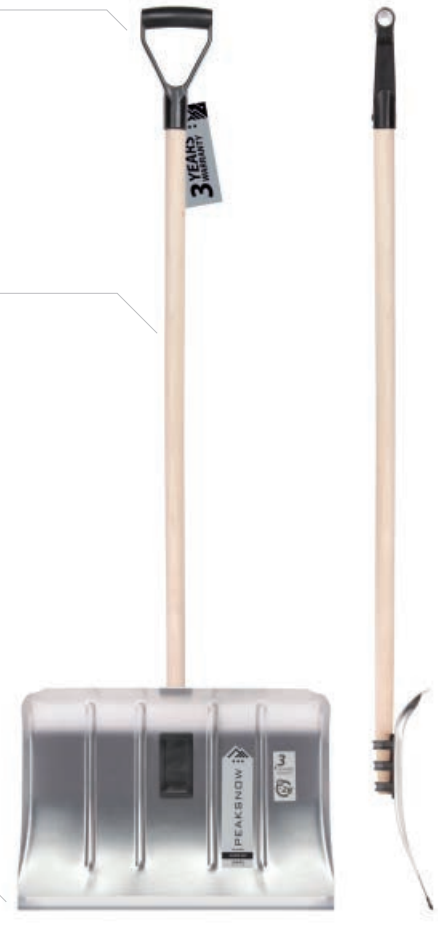
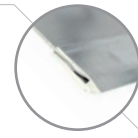

500 mm

60 mm

TOTAL 1450 mm

360 mm

PEAKSNOW



SKANDYNAWIA 2

aluminium shovel

	ILSK2
	ALU 5905197140506
	not assembled 600 1060
	assembled 80
	not assembled 12000 12000
	assembled 2640



D-grip IU-4

wooden shaft Ø 36 mm



340 mm

55 mm

TOTAL 1500 mm

350 mm

PEAKSNOW



ICE 1

ice hammer

	ICE1
	5905197199504
	STEEL
	assembled
	600
	assembled
	19800



wooden shaft Ø 28 mm



PEAKSNOW



ICE 2

ice hammer

	ICE2
	5905197199511
	STEEL
	assembled
	600
	assembled
	19800



wooden shaft Ø 28 mm

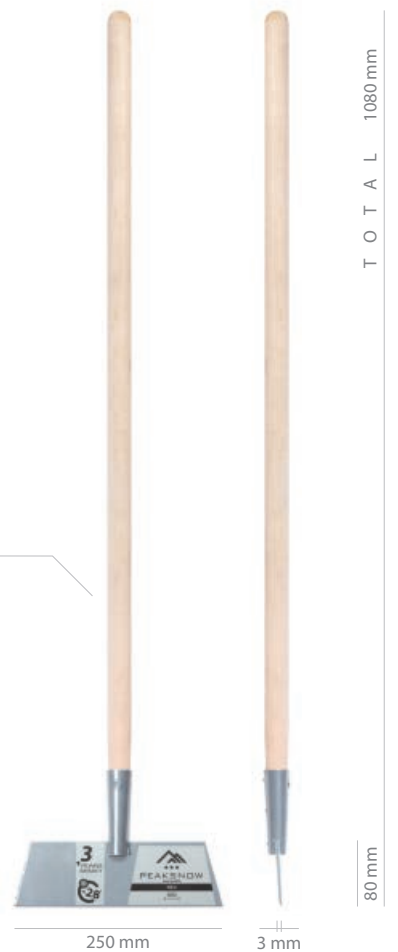

PEAKSNOW



ICE 3

ice hammer

		ICE3
	STEEL	5905197199481
	assembled	300
	assembled	9900



wooden shaft Ø 28 mm



SHARKIE

multipurpose spreading shovel

		ISSS
	B333/S411	5905197199542
	G642/S411	5905197067070
	assembled	960
	assembled	31680



KAJ

ice scraper

		IZS1
	MIX	5905197190303
	pcs	24000
	pcs	792000



GERDA

ice scraper

		IZS2
	MIX	5905197190310
	pcs	7680
	pcs	253440



ALASKA

ice scraper

		IZS3
	MIX	5905197190327
	pcs	9600
	pcs	316800



ALASKA PLUS

ice scraper

		IZS3A
	MIX	5905197190334
	assembled	2880
	assembled	95040



ICE CAR 2

folding set 2in1 – snow & ice

	IZCAR2
	MIX 5905197190419
	1440
	47520



brush
easy to assemble & disassemble

smooth rubber
squeegee

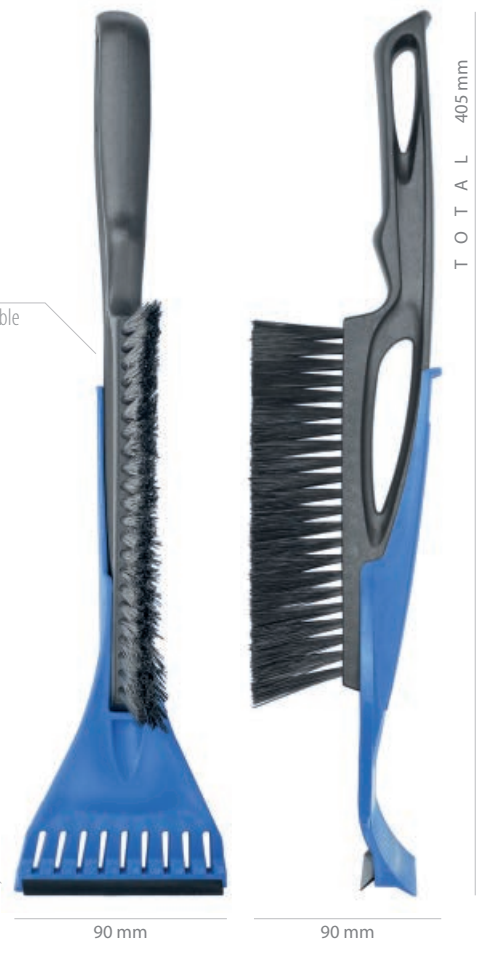

BOBO

multi-purpose shovel

	IL01
	3005U 5905197140452
	1788C 5905197095639
	205C 5905197096803
	pcs/not assembled 960 2000
	pcs/assembled 150
	pcs/not assembled 21120 21120
	pcs/assembled 9900



IGLOO COMFORT

multi-purpose shovel

	ILM2
	3005U 5905197140483
	1788C 5905197094069
	pcs/not assembled 840 2000
	pcs/assembled 150
	pcs/not assembled 19320 19320
	pcs/assembled 9900



IGLOO COMFORT ALU

multi-purpose shovel

		ILM2A
	3005U	5905197140377
	pcs/assembled	150
	pcs/assembled	9900



D-grip IU-1



KIDY

multi-purpose shovel

		ILCH
	3005U	5905197480077
	361C	5905197480084
	1788C	5905197480053
	205C	5905197480060
	pcs	6/12
	pcs	288
	pcs	9504



LOAD BABY

multi-purpose shovel

		IBLD
	3005U	5905197979847
	361C	5905197979854
	1788C	5905197979830
	pcs/not assembled	1200 3600
	pcs/assembled	384
	pcs/not assembled	30000 30000
	pcs/assembled	12672



LOAD BABY ALU

multi-purpose shovel

		IBLA
	3005U	5905197979816
	361C	5905197979823
	1788C	5905197979809
	pcs/assembled	384
	pcs/assembled	12672





FOCUS BABY

rake

		IBDG
	3005U	5905197979786
	361C	5905197979793
	1788C	5905197979779
	pcs/not assembled	2240 3600
	pcs/assembled	384
	pcs/not assembled	44800 44800
	pcs/assembled	12672

wooden shaft Ø 22 mm

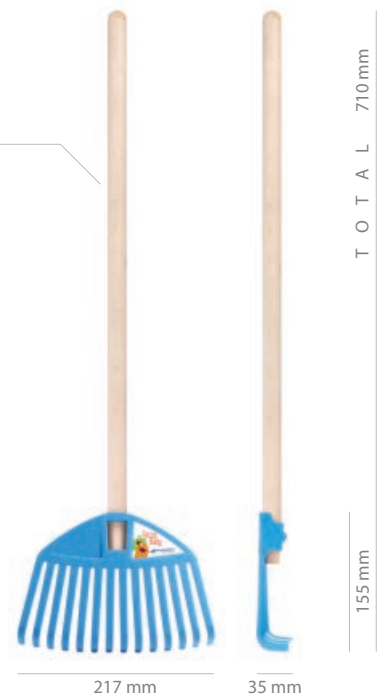



series

BASIC RANGE

SHOVELS



DURABLE



FLEXIBLE



4 SEASONS



THERMO-STOP



MULTI-PURPOSE

Nasze produkty projektowane są w taki sposób, aby ich recykling był możliwy i jak najprostszy. Zaawansowana technologia przetwarzania własnych tworzyw sztucznych pozwala na ponowne wykorzystanie powstałego surowca jako głównego składnika tworzywa. Narzędzia z serii BASIC RANGE potwierdzają, że produkty pochodzące z recyklingu są tak samo niezawodne, skuteczne oraz atrakcyjne wizualnie, jak artykuły wykonane z pierwotnego surowca.

Our products are designed in a way to reach the highest example of recent inventions in the world of plastic recycling and sustainability. The advanced technology of re-processing our materials allows us to reuse the material as the main component in any next production. BASIC Range is the best proof and confirms that products from recycling are just as reliable, effective and visually appealing as articles made of the original raw material.

zero waste
circular economy

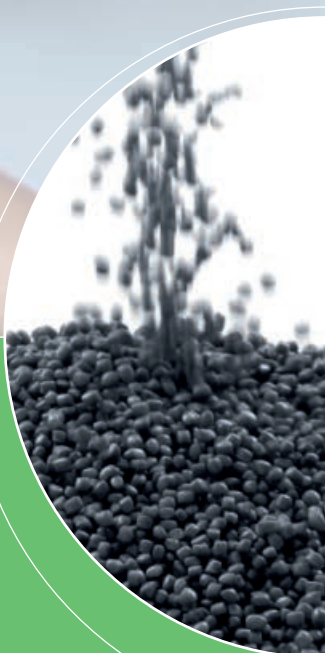



PRACTIC ECO

snow shovel

	ILT37		
	S411	5905197141312	
	not assembled	480	1440
	assembled	160	
	not assembled	10560	10560
	assembled	5280	



NONAME 41 ECO

snow shovel

	ILT41		
	S411	5905197141763	
	not assembled	360	1440
	assembled	160	
	not assembled	8640	8640
	assembled	5282	



D-grip IU-5

wooden shaft Ø 31 mm

uni-pack system

steel edge

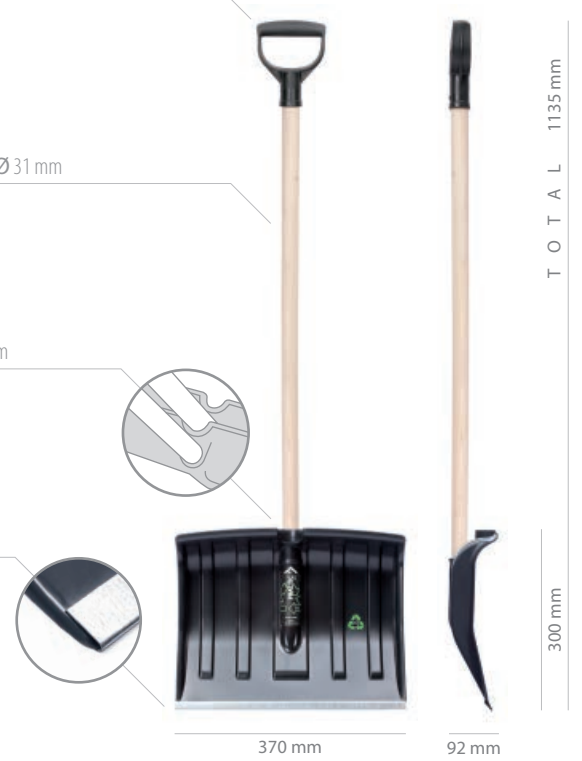

D-grip IU-5

wooden shaft Ø 31 mm

uni-pack system

steel edge

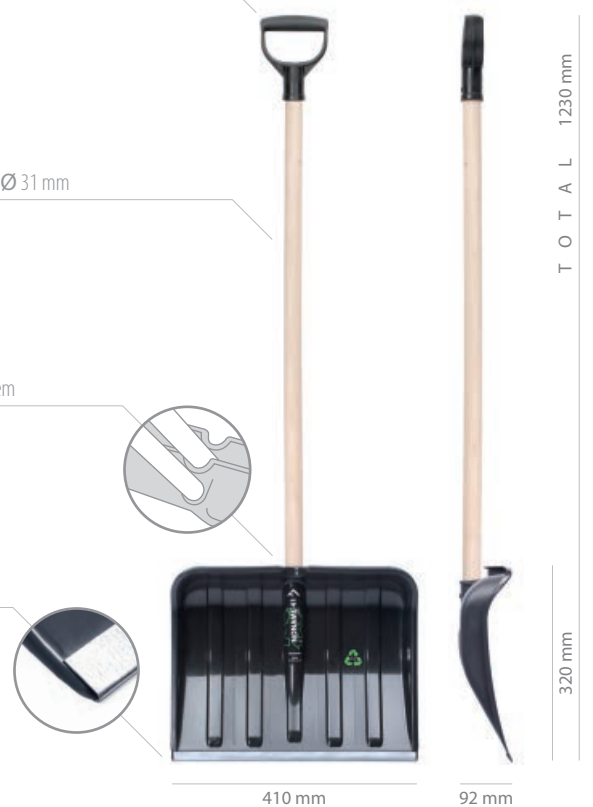



NONAME 47 ECO

snow shovel

	ILT47		
	S411	5905197141770	
	not assembled	300	1440
	assembled	100	
	not assembled	7500	7500
	assembled	3300	



ALPINUS ECO

snow shovel

	ILT55		
	S411	5905197141329	
	not assembled	160	1440
	assembled	70	
	not assembled	4480	4480
	assembled	2240	





ALPIN ALUTUBE ECO

snow shovel

	ILT2TB
	S411 5905197141343
	not assembled 300 350
	assembled 100
	not assembled 5400 5400
	assembled 3300



ALPINUS ALUTUBE ECO

snow shovel

	ILT3TB
	S411 5905197141350
	not assembled 160 350
	assembled 70
	not assembled 3680 3680
	assembled 2240



D-grip IU-4

aluminium handle Ø 30 mm
rubber athermal cover

uni-pack system

aluminium edge

D-grip IU-4

aluminium handle Ø 30 mm
rubber athermal cover

uni-pack system

aluminium edge

T O T A L 1450 mm

375 mm

490 mm

95 mm

T O T A L 1450 mm

385 mm

550 mm

105 mm



ALPE 50 ECO TELESCOPIC

snow shovel

	ILT50TSC
	S411 5905197141473
	not assembled 300 250
	assembled 100
	not assembled 5400 5400
	assembled 3300



NANGA ECO CAR TELESCOPIC

car shovel

	ILTNGTSC
	S411 5905197141992
	assembled 120
	assembled 7920





EVEREST ECO

car shovel

	ILTEV
	S411 5905197141336
	assembled 140
	assembled 9240





ARCTIC ECO

pusher

	ILTB
	S411 5905197141367
	not assembled + 50
	assembled 30
	not assembled + 3300
	assembled 990

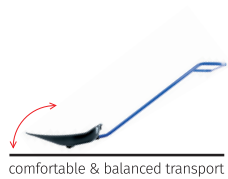

powder-coated metal handle Ø 20 mm

uni-pack system

aluminium edge

wheels

T O T A L 1270 mm

440 mm

800 mm

115 mm



ARCTIC L ECO

pusher

	ILTL
	S411 5905197141374
	not assembled 100 100
	assembled 18
	not assembled 1600 1600
	assembled 594



powder-coated metal handle Ø 22 mm

uni-pack system

aluminium edge

wheels

T O T A L 1495 mm

705 mm

670 mm

220 mm

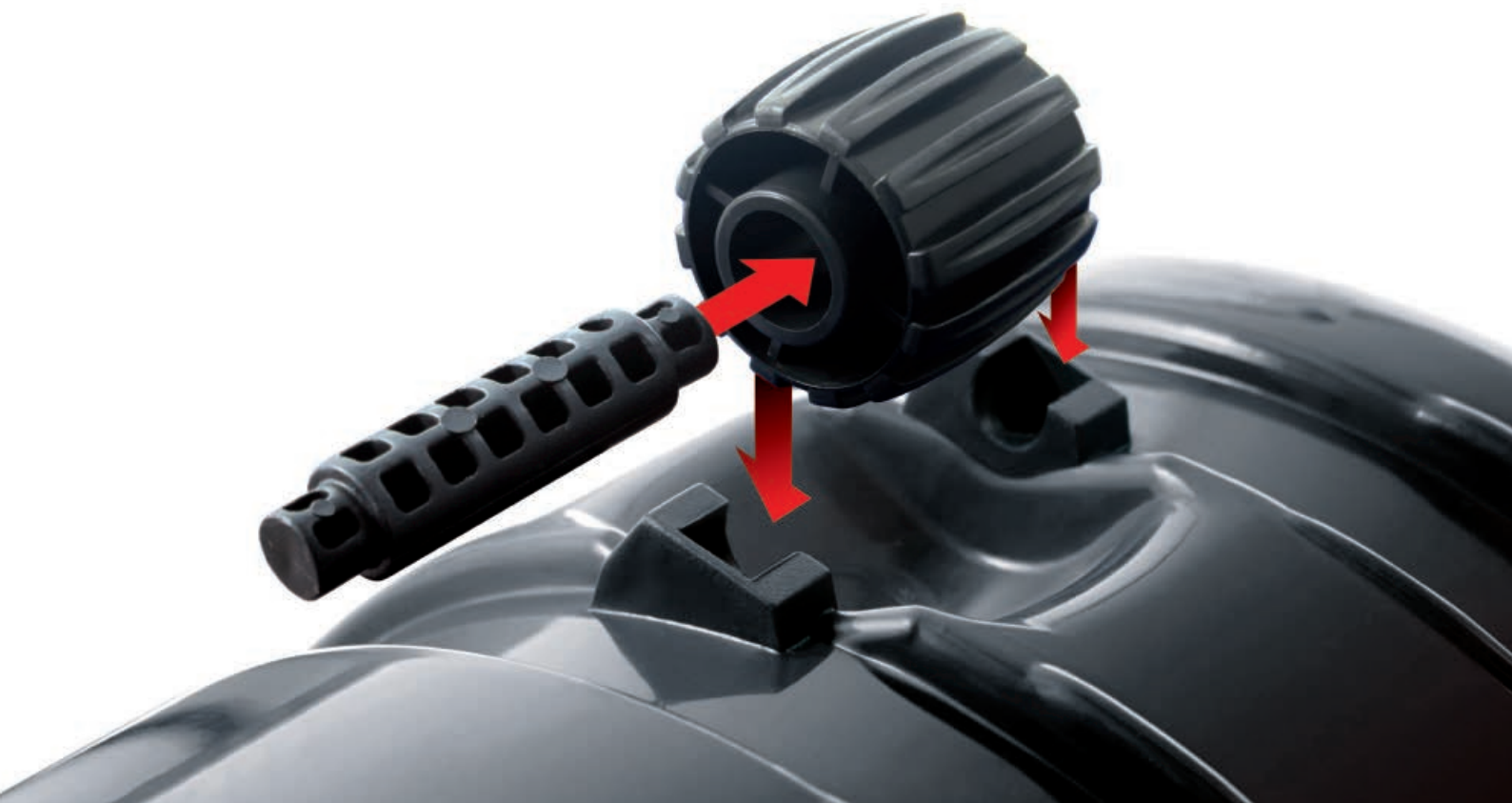

ASK FOR MOQ

YOUR OWN COMPOSITION OF VARIOUS
COLOURS & CUSTOMIZED FUNCTIONALITY

offer

SPECIAL ORDER



C
O
M
P
O
N
E
N
T
S

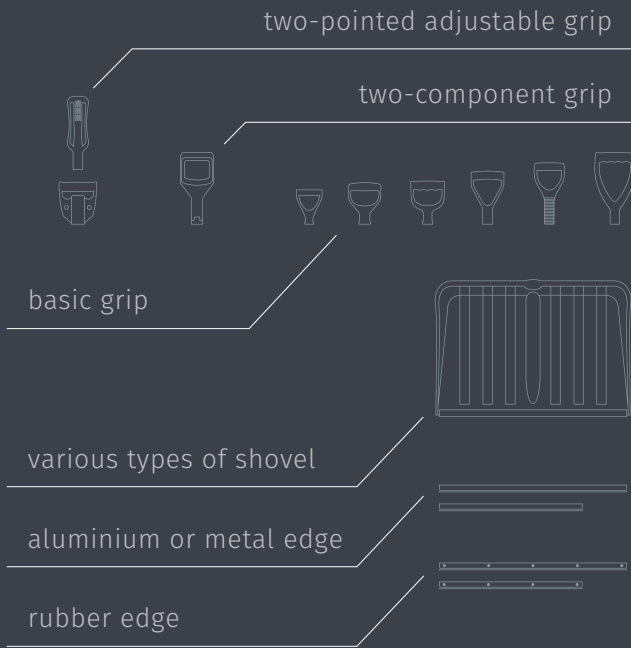

telescopic handle

wooden shaft

aluminium
or powder-coated
metal handle

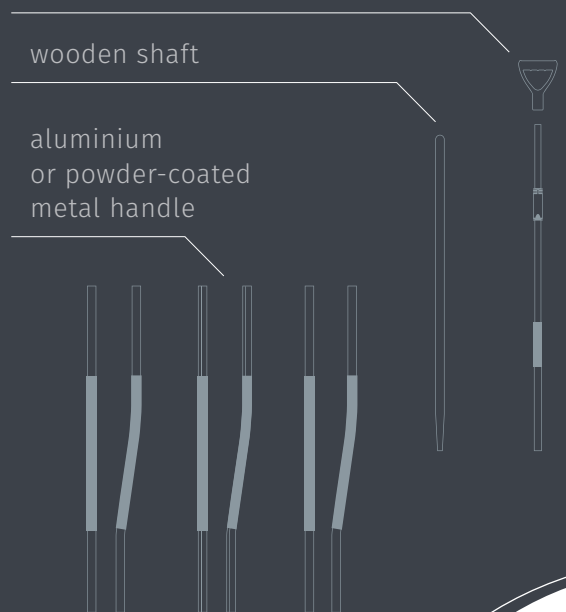

Wychodząc naprzeciw potrzebom rynku, obok produkcji seryjnej, realizujemy również zamówienia uwzględniające indywidualne potrzeby i preferencje. Szeroka gama oferowanych przez nas komponentów zapewnia konfigurację kompletnego narzędzia od podstawowych rozwiązań ogólnego stosowania po zaawansowane technicznie, wielozadaniowe warianty, umożliwiające maksymalizację wydajności. Segment SPECIAL ORDER pozwala również na niemal nieograniczony dobór kolorów.

In response to growing market demand, along with standard production, we are welcome any orders with individual needs and preferences. The wide range of components and materials we offer make it for us possible to fulfill orders almost in any configuration with diverse solutions, technical requests, multi-tasking varieties, efficiency. SPECIAL ORDER range also allows us to create an endless colour selection.

double
grip





PRACTIC ECO STANDARD

snow shovel

	ILT375
	S411 5905197141428
	not assembled 480 1440
	assembled 160
	not assembled 10560 10560
	assembled 5280



NONAME 41 ECO STANDARD

snow shovel

	ILT41S
	S411 5905197141442
	not assembled 360 1440
	assembled 160
	not assembled 8640 8640
	assembled 5282



ASK FOR MOQ | special order



CLEAN SET ECO

multi-purpose set 2in1

	ILTCL1
	S411 5905197142036
	assembled 45
	assembled 1485



ICE SET ECO

multi-purpose set 2in1

	ILTZICE1
	S411 5905197142005
	assembled 70
	assembled 2310

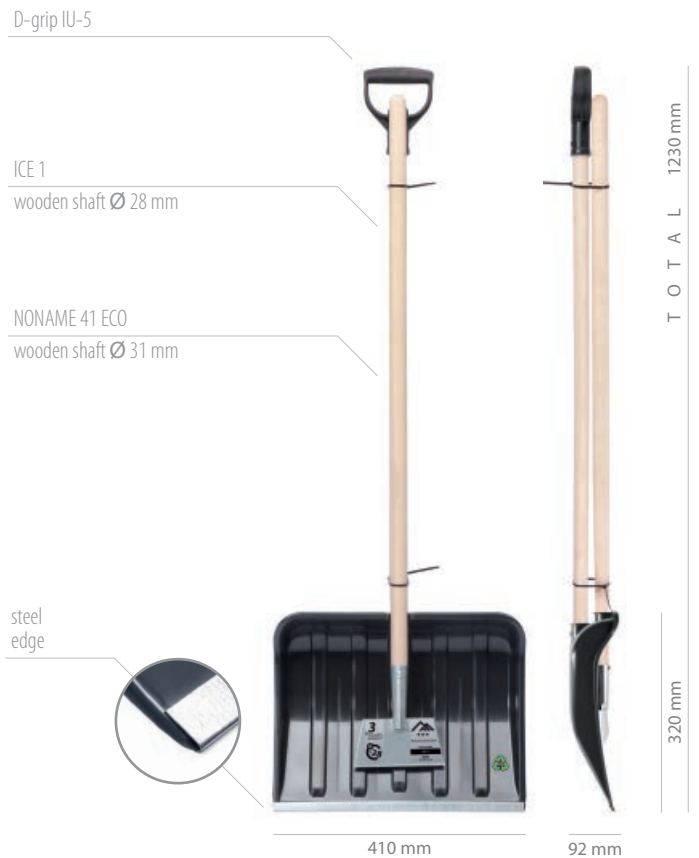



ALPIN ALUTUBE ERGO ECO

snow shovel

	ILT2TBE		
	S411	5905197141480	
	not assembled	300	350
	assembled	100	
	not assembled	5400	5400
	assembled	3300	



ALPINUS ALUTUBE ERGO ECO

snow shovel

	ILT3TBE		
	S411	5905197141954	
	not assembled	160	350
	assembled	70	
	not assembled	3680	3680
	assembled	2240	



D-grip IU-4

aluminium ergonomic handle Ø 30 mm
rubber athermal cover

uni-pack system

aluminium edge



D-grip IU-5

aluminium ergonomic handle Ø 30 mm
rubber athermal cover

uni-pack system

aluminium edge



ASK FOR MOQ | special order



ALPE 40 ECO TELESCOPIC

snow shovel

	ILT40TSC
	S411 5905197141466
	not assembled 360 250
	not assembled 5760 5760



NANGA ECO CAR

car shovel

	ILTNG
	S411 5905197141978
	not assembled 420 3500
	assembled 130
	not assembled 9240 9240
	assembled 4290



D-grip IU-11

telescopic system

aluminium handle Ø 26/30 mm
athermal cover

uni-pack system

aluminium edge



D-grip IU-5

wooden shaft Ø 31 mm

uni-pack system





NANGA ECO

snow shovel

		ILT30
	S411	5905197141411
	not assembled	420 1440
	assembled	184
	not assembled	9240 9240
	assembled	5888



NANGA ECO CAR ALU

car shovel

		ILTNGA
	S411	5905197141985
	assembled	140
	assembled	9240



D-grip IU-5

wooden shaft Ø 31 mm

uni-pack system

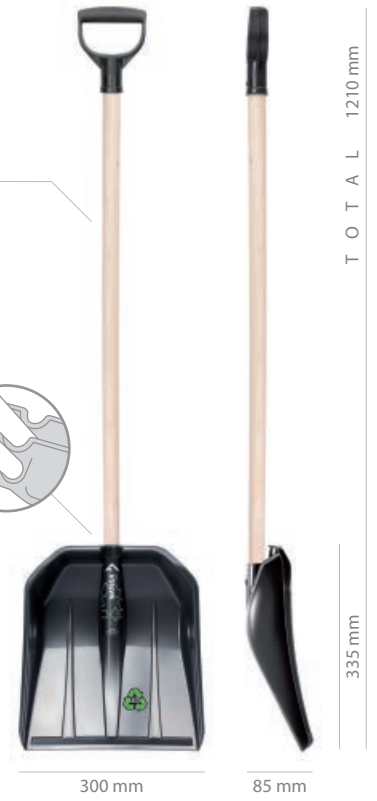

D-grip IU-11

aluminium handle Ø 30 mm

uni-pack system

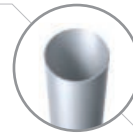

ASK FOR MOQ | special order



NANGA ECO TELESCOPIC snow shovel

	ILT30TSC
	S411 5905197141459
	assembled 120
	assembled 7920



D-grip IU-11

telescopic system

aluminium handle Ø 26/30 mm
athermal cover

uni-pack system



ASK FOR MOQ | special order



PEAKSNOW



ALPIN 1

snow shovel

	IL1
	B333 5905197740515
	not assembled 360 1440
	assembled 160
	not assembled 8640 8640
	assembled 5280

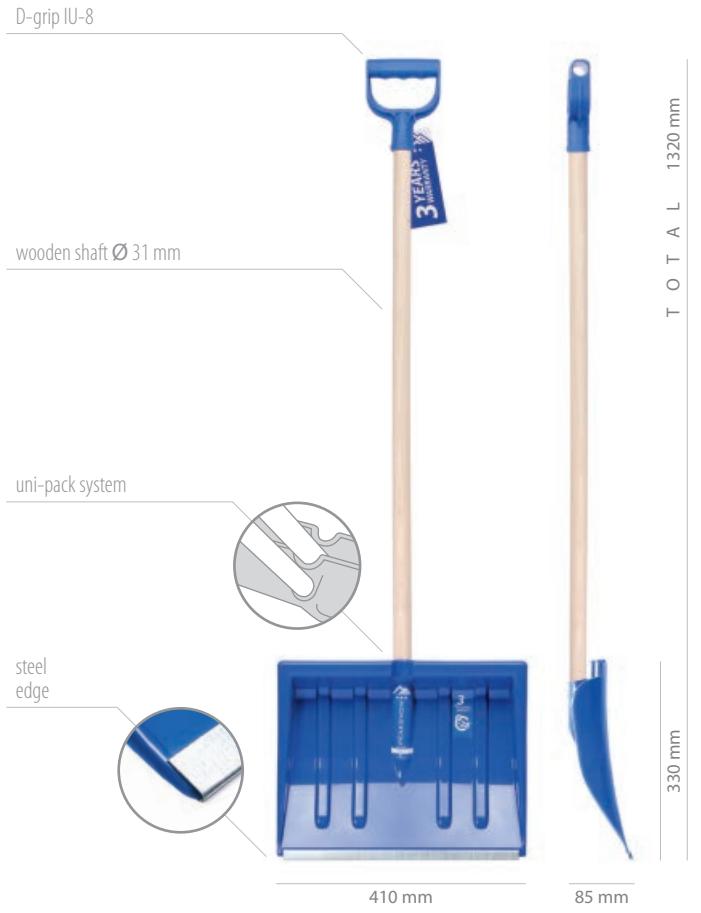

PEAKSNOW



ALPIN 2

snow shovel

	IL2
	B333 5905197740522
	not assembled 300 1440
	assembled 100
	not assembled 7500 7500
	assembled 3300



ASK FOR MOQ | special order

PEAKSNOW



ALPIN 2 ALUTUBE ERGO snow shovel

	IL2TBE
	B333 5905197142067
	not assembled 300 350
	assembled 100
	not assembled 5400 5400
	assembled 3300



D-grip IU-4

aluminium ergonomic handle Ø 30 mm
rubber athermal cover

uni-pack system

aluminium edge



PEAKSNOW



ALPINUS A snow shovel

	IL3A
	B333 5905197141251
	not assembled 160 1440
	assembled 70
	not assembled 4480 4480
	assembled 2240



D-grip IU-8

wooden shaft Ø 31mm

uni-pack system

aluminium edge



PEAKSNOW



ALPINUS METAL

snow shovel

	RL3AMT
	R395 5905197131030
	not assembled 160 350
	assembled 70
	not assembled 3680 3680
	assembled 2240



D-grip IU-4

powder-coated metal handle Ø 30 mm
rubber athermal cover

uni-pack system

aluminium edge



PEAKSNOW



ALPINUS ERGOMETAL

snow shovel

	IL3FE
	B333 5905197141282
	not assembled 160 350
	assembled 70
	not assembled 3680 3680
	assembled 2240



D-grip IU-4

powder-coated metal ergonomic handle Ø 30 mm
rubber athermal cover

uni-pack system

aluminium edge



ASK FOR MOQ | special order

PEAKSNOW



ALPINUS ERGOMETAL snow shovel

	RL3FE
	R395 5905197131047
	not assembled 160 350
	assembled 70
	not assembled 3680 3680
	assembled 2240



D-grip IU-4

powder-coated metal ergonomic handle Ø 30 mm
rubber athermal cover

uni-pack system

aluminium edge



PEAKSNOW



ALPINUS TELESCOPIC snow shovel

	IL55TSC
	B333 5905197142081
	not assembled 160 250
	not assembled 3680 3680



D-grip IU-11

telescopic system

aluminium handle Ø 26/30 mm
athermal cover

uni-pack system

aluminium edge



PEAKSNOW



ERGONOMIC 1 A

snow shovel

	ILE1A
	B333 5905197141664
	not assembled 360 1440
	assembled 160
	not assembled 8640 8640
	assembled 5280



PEAKSNOW



ERGONOMIC 2 A

snow shovel

	ILE2A
	B333 5905197141688
	not assembled 200 1440
	assembled 100
	not assembled 4800 4800
	assembled 3300



ASK FOR MOQ | special order

PEAKSNOW



ERGO ALUTUBE

snow shovel

	ILETB		
	B333	5905197141305	
	not assembled	200	350
	assembled	100	
	not assembled	4200	4200
	assembled	3300	



PEAKSNOW



ALPE 40 TELESCOPIC

snow shovel

	IL40TSC		
	B333	5905197142050	
	not assembled	360	250
	not assembled	5760	5760



ASK FOR MOQ | special order

PEAKSNOW



NANGA

snow shovel

	IL30
	B333 5905197142043
	not assembled 420 1440
	assembled 184
	not assembled 9240 9240
	assembled 5888



PEAKSNOW



LHOTSE [+ SACK]

snow shovel

	ILHOTW
	B333 5905197142234
	assembled 120
	assembled 7920



ASK FOR MOQ | special order

PEAKSNOW



★★★★☆
STANDARD

SNOW RIDER 2

pusher

	ILSR2
	S411 5905197140582
	not assembled + 30
	assembled 30
	not assembled + 1980
	assembled 990



powder-coated metal handle Ø 22 mm

uni-pack system

aluminium edge

wheels



T O T A L 1350 mm

525 mm

800 mm

125 mm

PEAKSNOW



★★★★☆
STANDARD

ALUICE 40 P

aluminium shovel

	ILALP4
	ALU 5905197141602
	not assembled 600 1500
	assembled 60
	not assembled 12000 12000
	assembled 1980



D-grip IU-4

wooden shaft Ø 30 mm

aluminium edge



T O T A L 1450 mm

350 mm

400 mm

60 mm

PEAKSNOW



SKANDYNAWIA STANDARD

aluminium shovel

	ILSK2S
	ALU 5905197140391
	not assembled 600 1500
	assembled 80
	not assembled 12000 12000
	assembled 2640



PEAKSNOW



RUBBER COVER

for ICE 1 - ICE 2 - ICE 3

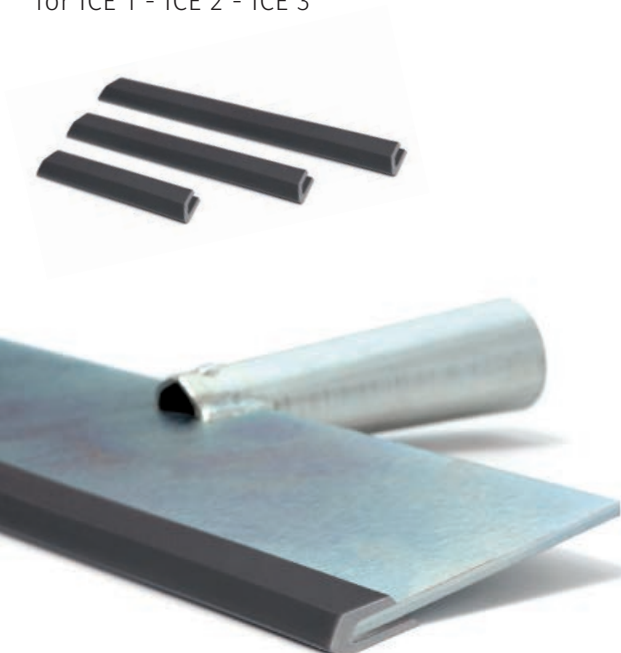

ASK FOR MOQ | special order

PEAKSNOW



CLEAN SET

multi-purpose set 2in1

	ZCLE1
	B333 5905197199023
	assembled 45
	assembled 1485



PEAKSNOW



ICE SET

multi-purpose set 3in1

	ZICE1
	B333 STEEL 5905197199016
	assembled 70
	assembled 2310

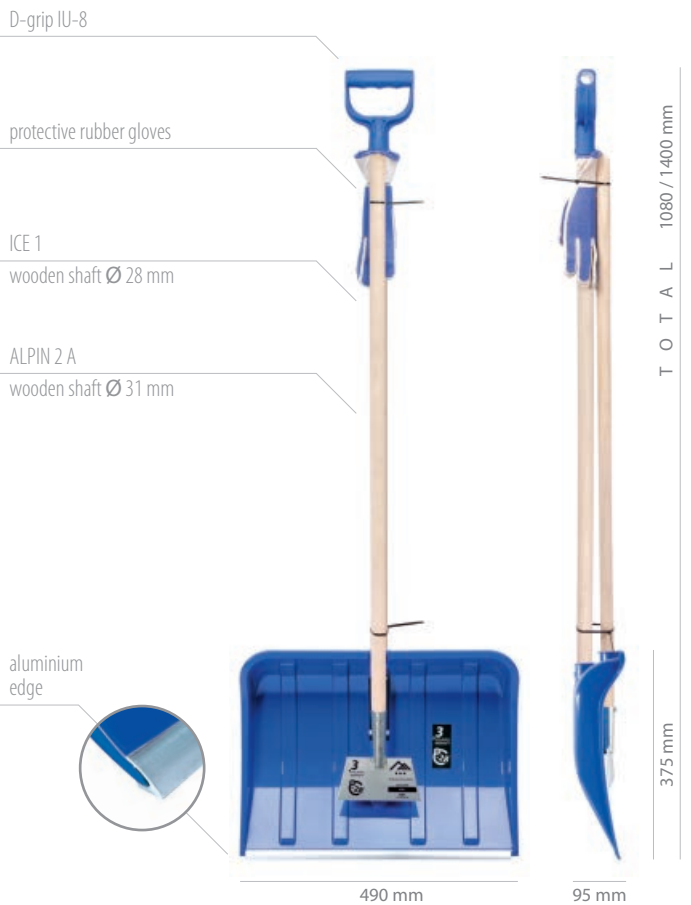

PEAKSNOW



★★★★☆
STANDARD

FAMILY SET

multi-purpose set 2in1

	ZFAM
	B333 1788C 5905197199047
	assembled 70
	assembled 2310



ALPIN 1 A
D-grip IU-8
wooden shaft Ø 31 mm

IGLOO COMFORT
D-grip IU-1
wooden shaft Ø 24 mm

aluminium edge

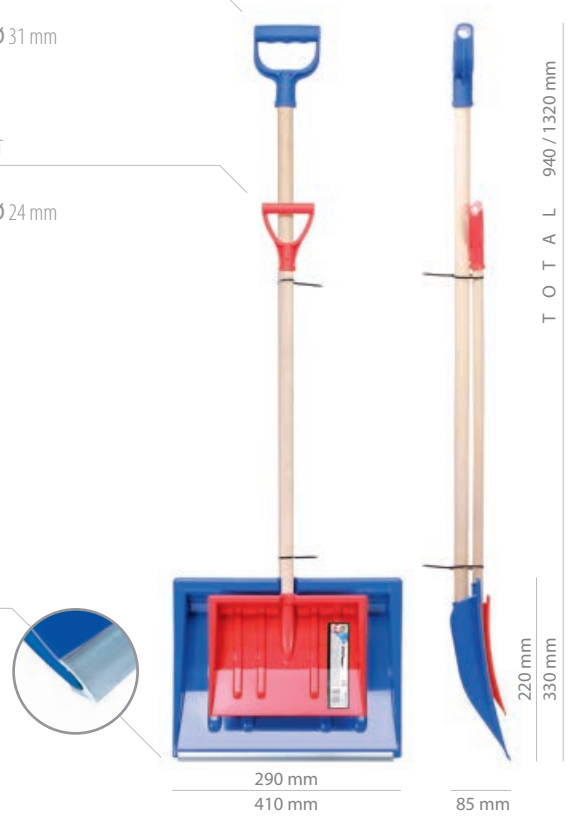

T O T A L 940 / 1320 mm

220 mm
330 mm

PEAKSNOW



★★★★☆
STANDARD

KID SET

multi-purpose set for kids 2in1

	ZKID
	3005U 1788C 5905197199030
	pcs/assembled 100
	pcs/assembled 3300



D-grip IU-1

lightweight brush
wooden shaft

IGLOO COMFORT
wooden shaft Ø 24 mm

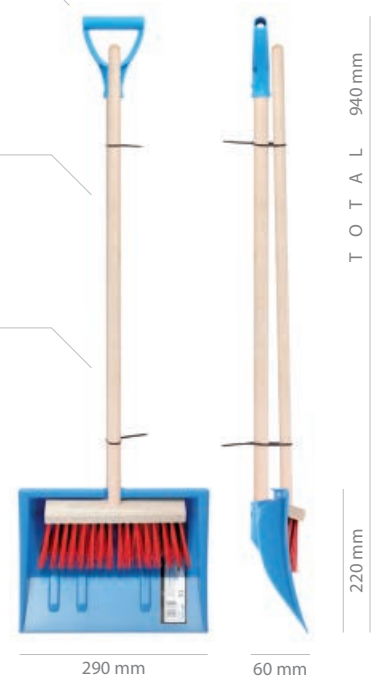

T O T A L 940 mm











220 mm

290 mm

60 mm

BOBO COMFORT

multi-purpose shovel

		IL02
	3005U	5905197140469
	1788C	5905197069661
	pcs/not assembled	 960  2000
	pcs/assembled	 150
	pcs/not assembled	 21120  21120
	pcs/assembled	 9900



D-grip IU-1





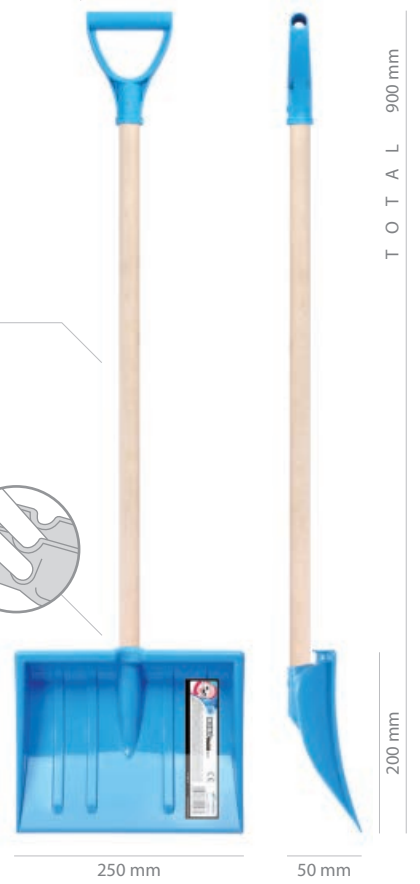
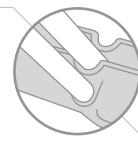

wooden shaft Ø 24 mm

uni-pack system



BOBO COMFORT ALU

multi-purpose shovel

		IL02A
	3005U	5905197140384
	1788C	5905197095646
	pcs/assembled	 150
	pcs/assembled	 9900



D-grip IU-1

aluminium handle Ø 22 mm

uni-pack system

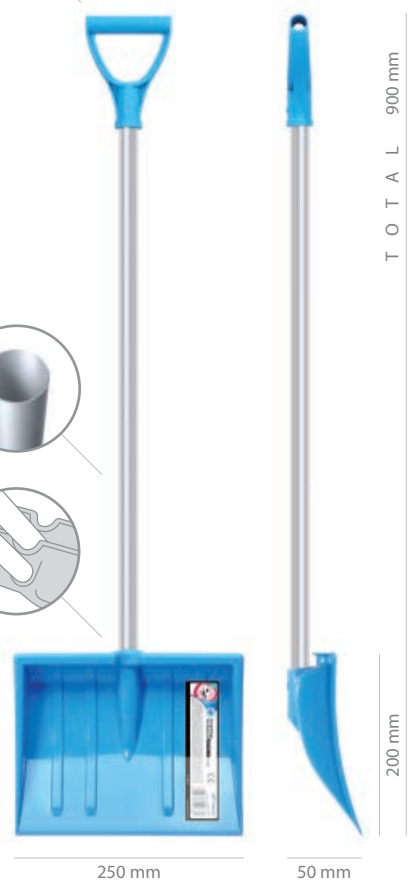

IGLOO

multi-purpose shovel

	ILM1
	3005U 5905197140476
	1788C 5905197095714
	205C 5905197097305
	pcs/not assembled 840 2000
	pcs/assembled 150
	pcs/not assembled 19320 19320
	pcs/assembled 9900



MAJSTER

professional shovel

	ILMSTA
	B333 5905197141572
	not assembled 200 300
	assembled 70
	not assembled 4200 4200
	assembled 2240



ASK FOR MOQ | special order

PEAKSNOW



DIABLO ERGO

professional shovel



ILDBE



R444

5905197142203



not assembled



160



300

assembled



70



not assembled



3360



3360

assembled



2240



PEAKSNOW



ERGOSPECIAL S

professional shovel



ILEXS



B333

5905197141565



not assembled



160



320

assembled



70



not assembled



3520



3520

assembled



2240



D-grip IU-9

aluminium ergonomic oval handle
rubber athermal cover

uni-pack system

steel edge



D-grip IU-9

aluminium ergonomic oval handle
rubber athermal cover

uni-pack system

rubber edge





ERGOSPECIAL C

professional shovel

	ILEX55C
	B333 5905197142296
	not assembled 160 160
	assembled 70
	not assembled 2560 2560
	assembled 2240



TOTAL 1550 mm

380 mm

550 mm

120 mm

special order



ERGOSPECIAL C

professional shovel

	RLEX55
	R395 5905197131078
	not assembled 160 160
	assembled 70
	not assembled 2560 2560
	assembled 2240



TOTAL 1550 mm

380 mm

550 mm

120 mm

ASK FOR MOQ

Category index

BASIC SHOVELS WITH WOODEN SHAFT



ALPIN 1

p. 65



ALPIN 1 A

p. 27



ALPIN 2

p. 65



ALPIN 2 A

p. 27



ALPINUS A

p. 66



ERGONOMIC 1 A

p. 69



ERGONOMIC 2 A

p. 69



STANDARD 1

p. 31



STANDARD 2

p. 32



NANGA

p. 71



PRACTIC ECO STANDARD

p. 59



PRACTIC ECO

p. 51



NONAME 41 ECO STANDARD

p. 59



NONAME 41 ECO

p. 51



NONAME 47 ECO

p. 52



ALPINUS ECO

p. 52



NANGA ECO

p. 63



ALPE 40 TELESCOPIC

p. 70



ALPE 50 TELESCOPIC

p. 31



NANGA CAR TELESCOPIC

p. 32



ALPINUS TELESCOPIC

p. 68

TELESCOPIC SYSTEM



ALPE 40 ECO TELESCOPIC

p. 62



ALPE 50 ECO TELESCOPIC

p. 54



NANGA ECO CAR TELESCOPIC

p. 54





































NANGA ECO TELESCOPIC

p. 64



SHOVELS
WITH
METAL HANDLE

				
SNOWER 40 ALUTUBE	SNOWER 40 PROFI	SNOWER 40 PROFI ERGO	SNOWER 50 ALUTUBE	SNOWER 50 PROFI
p. 10	p. 11	p. 11	p. 12	p. 13
				
SNOWER 50 PROFI ERGO	SNOWER 55 ALUTUBE	SNOWER 55 PROFI	SNOWER 55 PROFI ERGO	SNOWER 55D ALUTUBE
p. 13	p. 14	p. 15	p. 15	p. 16
				
SNOWER 55D PROFI	SNOWER 55D PROFI ERGO	RAKE LOADER	DIABLO	DIABLO ERGO
p. 17	p. 17	p. 18	p. 19	p. 78
				
MAJSTER	ERGOSPECIAL	ERGOSPECIAL S	ERGOSPECIAL C	ERGOSPECIAL C
p. 77	p. 19	p. 78	p. 79	p. 79
				
ALPIN 2 METAL	ALPIN 2 ALUTUBE	ALPIN 2 ALUTUBE ERGO	ALPINUS ALUTUBE	ALPINUS ALUTUBE ERGO
p. 28	p. 28	p. 66	p. 29	p. 30
				
ALPINUS METAL	ALPINUS METAL	ALPINUS ERGOMETAL	ALPINUS ERGOMETAL	ERGOMETAL
p. 29	p. 67	p. 67	p. 68	p. 30
				
ERGO ALUTUBE	ALPIN ALUTUBE ECO	ALPIN ALUTUBE ERGO ECO	ALPINUS ALUTUBE ECO	ALPINUS ALUTUBE ERGO ECO
p. 70	p. 53	p. 61	p. 53	p. 61

Category index

PUSHER SERIES



SNOW MOVER

p. 6



SNOW MONSTER

p. 20



SNOW RIDER 2

p. 72



SNOW RIDER 1

p. 34



ARCTIC

p. 34



ARCTIC L

p. 35



ARCTIC XL

p. 35



ARCTIC ECO

p. 56



ARCTIC L ECO

p. 56



STRONGMAN 60

p. 36



STRONGMAN 80

p. 36

ALUMINIUM SHOVELS



ALUEDGE

p. 23



ALUEDGE ERGO

p. 23



ALUMAX

p. 24



ALUMAX S

p. 24



ALUMAX ERGO

p. 25



ALUICE 40

p. 38



ALUICE 40 P

p. 72



ALUICE 50

p. 38



ALUICE 50 P

p. 39



SKANDYNAWIA STANDARD

p. 73



SKANDYNAWIA 2

p. 39

ICE & ACCESSORIES



ICE 1

p. 40



ICE 2

p. 40



ICE 3

p. 41



RUBBER COVER for ICE 1, ICE 2, ICE 3

p. 73



SHARKIE

p. 41

CAR SHOVELS & ACCESSORIES



EVEREST

p. 33



LHOTSE

p. 33



LHOTSE [+ SACK]

p. 71



NANGA CAR TELESCOPIC

p. 32



MAKALU

p. 22



EVEREST ECO

p. 55



NANGA ECO CAR

p. 62



NANGA ECO CAR ALU

p. 63



NANGA ECO CAR TELESCOPIC

p. 54



KAJ

p. 42



GERDA

p. 42



ALASKA

p. 43



ALASKA

p. 43



FROST

p. 44



ICE CAR 1

p. 44



ICE CAR 2

p. 45

SET



CLEAN SET

p. 74



ICE SET

p. 74



FAMILY SET

p. 75



KID SET

p. 75



CLEAN SET ECO

p. 60



ICE SET ECO

p. 60

FOR KIDS



BOBO

p. 46



BOBO COMFORT

p. 76



BOBO COMFORT ALU

p. 76



IGLOO

p. 77



IGLOO COMFORT

p. 46



IGLOO COMFORT ALU

p. 47



KIDY

p. 47



LOAD BABY

p. 48



LOAD BABY ALU

p. 48



FOCUS BABY

p. 49



KID SET

p. 75



Constantly launching an innovative, diversified and high quality products and being a reliable partner, we managed to succeed on the market in different parts of the world.

Currently our products are successfully distributed to more than 90 countries worldwide and the number of satisfied customers is increasing each year!

over 90 countries worldwide

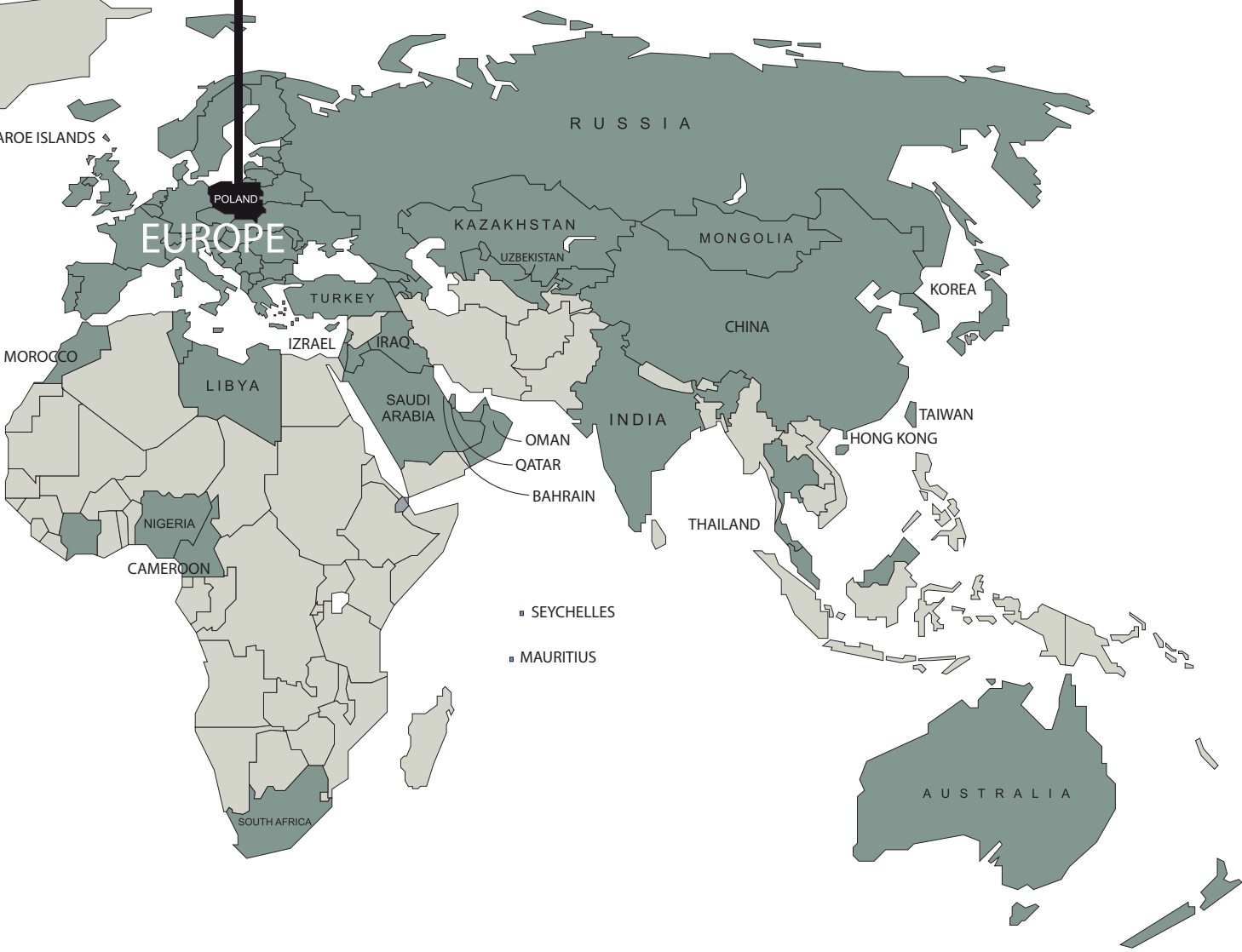



Logistics & packing method



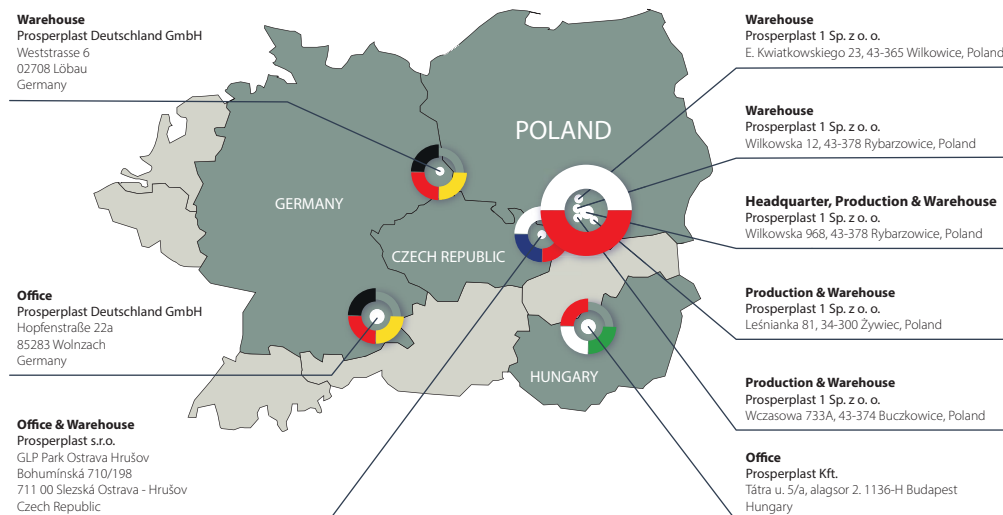

Contact us

Poland

Headquarter, Production & Warehouse

Prosperplast 1 Sp. z o. o.
Wilkowska 968
43-378 Rybarzowice
Poland

tel. +48 33 817 70 03
fax +48 33 817 60 81

biuro@prosperplast.pl
office@prosperplast.pl
www.prosperplast.pl

Germany

Office

Prosperplast Deutschland GmbH
Hopfenstraße 22a
85283 Wolnzach
Germany

tel. +49 8442 9628499
fax +49 8442 9680853

kontakt@prosperplast.de
www.prosperplast.de

Czech Republic

Office & Warehouse

Prosperplast s.r.o.
CTPark Ostrava Hrušov
Bohumínská 710/198
711 00 Slezská Ostrava - Hrušov
Czech Republic

tel. +420 553 034 443
mob +420 605 499 544

info@prosperplast.cz
www.prosperplast.cz

Hungary

Office

Prosperplast Kft.
Tátra u. 5/a, alagsor 2.
1136-H Budapest,
Hungary

tel. +36 30 4095 120
mob +36 30 4095 710

office@prosperplast.hu
www.prosperplast.hu

Wszystkie prawa zastrzeżone przez Prosperplast 1 Spółka z o.o., a zawartość nie może być powielana, pobierana, rozpowszechniana, publikowana lub przekazywana w jakiegokolwiek formie i w jakikolwiek sposób, bez uprzedniej pisemnej zgody Prosperplast 1 Spółka z o.o.
Niniejszy katalog nie stanowi oferty w rozumieniu obowiązujących przepisów. Za błędy w druku nie odpowiadamy.

All rights are reserved by Prosperplast 1 Spółka z o. o. and content may not be reproduced, downloaded, disseminated, published, or transferred in any form or by any means, except with the prior written permission of Prosperplast 1 Spółka z o.o.
This catalogue does not constitute an offer within the meaning of applicable rules. We are not responsible for printing errors.



Prosperplast 1 Sp. z o.o.
Wilkowska 968
43-378 Rybarzowice
Poland